

DeMaMech 2005 Exchange Program

Masahiro Nishimura

Summary

01.Sep.05 – 23.Dec.05

Katholieke Universiteit Leuven

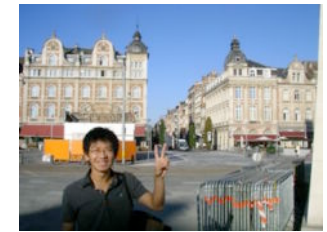

02.Jan.06 – 21.Jan.06

Technical University of Denmark



Research

Task : To design and fabricate a micro tube polishing machine

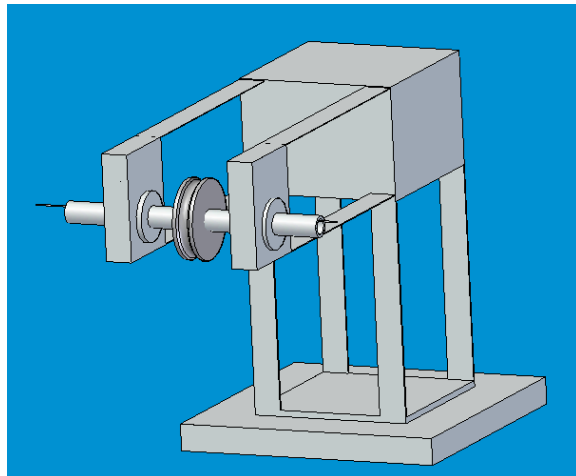
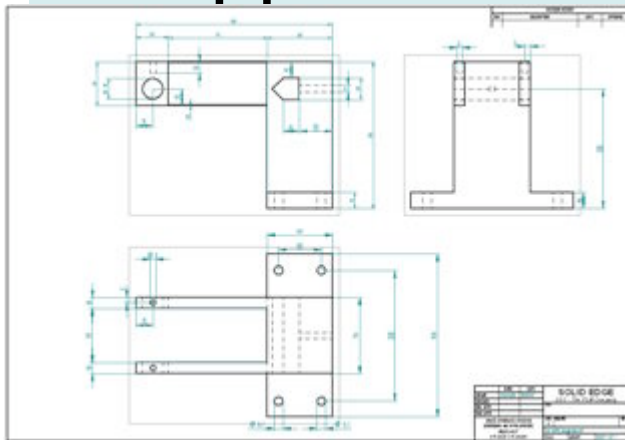
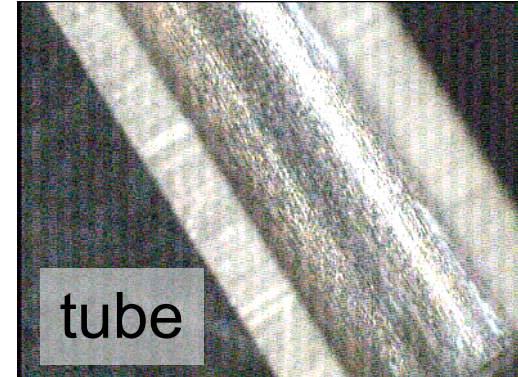

3DCAD

Micro tube polishing machine

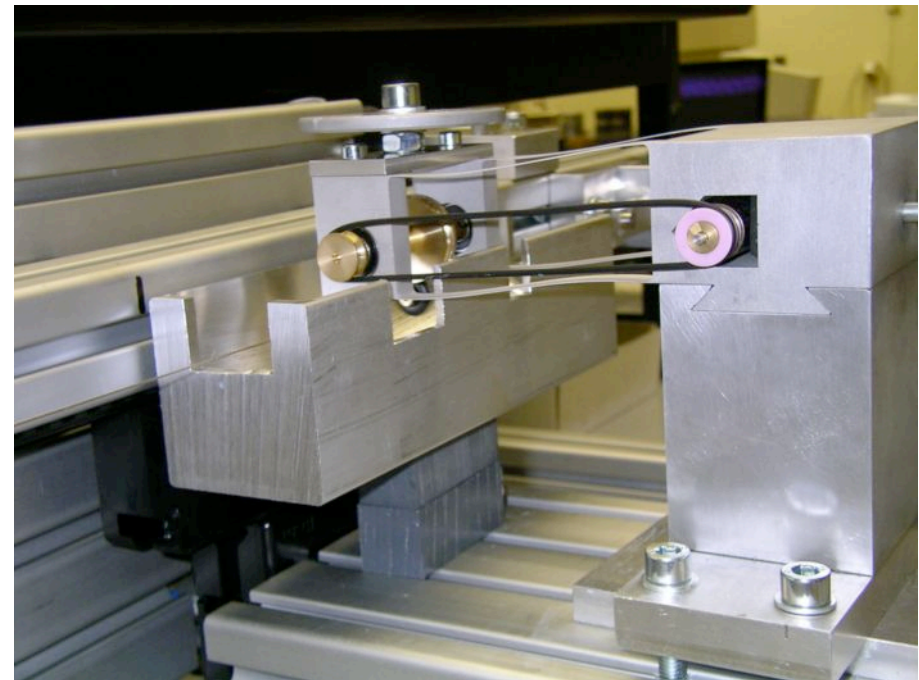

Lecture

Task : To classify and visualize music



← Graphical contents written by OpenGL

Music classification →

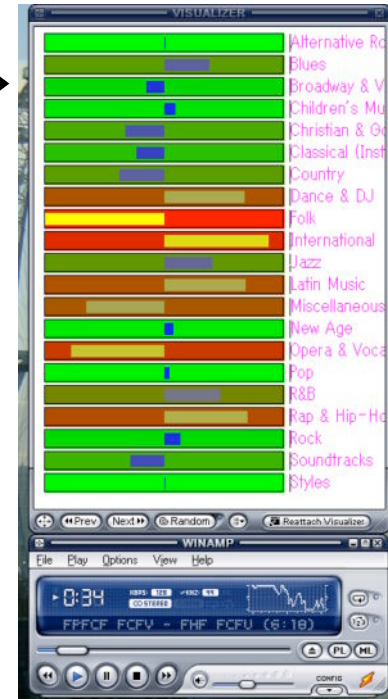

To classify and Visualize a music

Daily Life



study

friendship

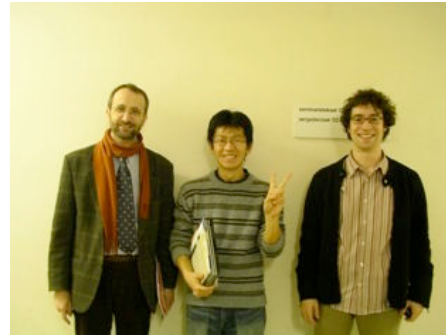
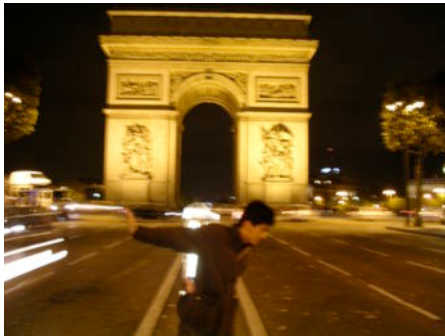

travel

Food and Drink

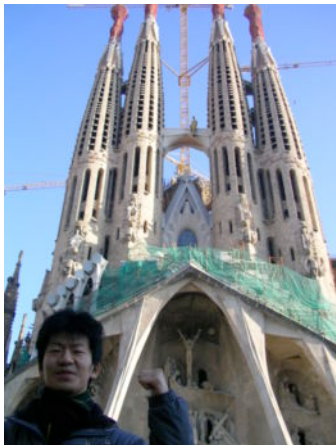

Thanks for every wonderful meeting...